

**DP2000**

**7-In-1 Ultra WiFi Internet Wireless  
Weather Station**

Manual EN





The logo for froggit.de is displayed in a large, bold, black font. The word 'froggit' is in a lowercase, sans-serif font, and '.de' is in a smaller, lowercase, sans-serif font. The logo is centered on a light beige background.



Support/updates/manuals/spare parts:  
[www.froggit.de](http://www.froggit.de)

The following optional sensors (purchased separately) can be used with DP2000 console display.

If you have purchase extra sensors, just simple power up, the display console will receives the data automatically. If sensor not reporting in to console, the display console will re-search the data after one hour or restart the console to search the data. Please refer to the sensor manual (provided separately with sensor) for details.

This table shows the maximum number of each type of sensor that can be worked with console display

<b>Sensor</b>	<b>Image</b>	<b>Maximum Number</b>
DP50 Multi-channel temperature and humidity sensor		8
DP100 Soil moisture sensor		8
DP200 PM2.5 air quality sensor		1
DP70 Water leak alarm		4
DP60 Thunder and lightning		1

<p>DP250 Indoor PM2.5/PM10 CO2 air quality sensor temperature/humidity</p>		<p>1</p>
<p>DP10 Leaf wetness sensor * the data won't be displayed on the main screen, it will show its data on the Channel Data page.</p>		<p>8</p>
<p><b>Sensor</b></p>	<p><b>Image</b></p>	<p><b>Maximum Number</b></p>
<p>DP35 stainless-steel probe thermometer for soil and water DP150 wire probe thermometer for water DP35 and DP150 share the 8 channels</p>		<p>8</p>

# Table of Contents

<b>1 TABLE OF CONTENTS .....</b>	<b>4</b>
<b>2 UNPACKING.....</b>	<b>5</b>
<b>3 OVERVIEW.....</b>	<b>5</b>
<b>4 SENSOR ARRAY SET UP .....</b>	<b>8</b>
4.1 INSTALL BATTERIES.....	8
4.2. MOUNTING .....	8
4.3 RESET BUTTON AND TRANSMITTER LED .....	11
4.4. CALIBRATION .....	11
4.5 SITE SURVEY .....	11
4.6 BEST PRACTICES FOR WIRELESS COMMUNICATION .....	12
<b>5 WI-FI CONFIGURATION.....</b>	<b>13</b>
5.1 BEFORE SETUP .....	13
5.2 SETUP METHOD.....	13
5.2.1 Method A: Setup via app.....	13
5.2.2 Method B: Setup via Embedded Webpage.....	15
5.3 REGISTERING ECOWITT WEATHER SERVER.....	19
5.3.1 Viewing data on ecowitt.net.....	20
5.4 REGISTERING WEATHER UNDERGROUND .....	23
5.4.1 Viewing data on wunderground.com .....	27
5.5 REGISTERING WEATHERCLOUD .....	30
5.6 WEATHER OBSERVATIONS WEBSITE (WOW) .....	31
5.7 EMBEDDED WEBPAGE OTHER FUNCITONS .....	35
2. LIVE DATE.....	36
<b>6 MAINTENANCE.....</b>	<b>41</b>
<b>7 TROUBLESHOOTING GUIDE .....</b>	<b>44</b>
<b>8 SPECIFICATIONS.....</b>	<b>47</b>

# Unpacking

Open your weather station box and inspect that the contents are intact (nothing broken) and complete (nothing missing). Inside you should find the following:

QT	Item Description
1	Wi-Fi /LAN Gateway
1	7-in-1 Sensor Array with built-in: Thermo-hygrometer / Rain Gauge / Wind Speed Sensor/ Wind Direction Sensor/UV/Light sensor, Solar panel
1	White O-ring
1	USB to 2.5*0.7mm DC 5V power plug connector cable
1	Ethernet Cable
1	User manual (this manual)

**Table 1: Package content**

If any component is missing from the package, or broken, please contact our Customer Service department to resolve the issue.

## Overview

### WiFi/Lan Gateway

7	Server LED
6	Sensor Link LED
5	Temp. & Humidity Sensor
4	Network LED
3	Ethernet socket
2	DC Socket
1	Reset button
No	Description

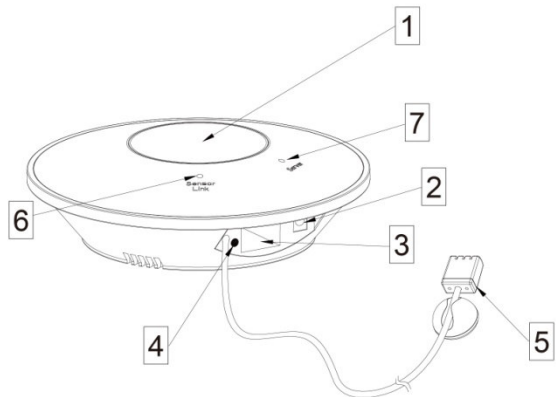
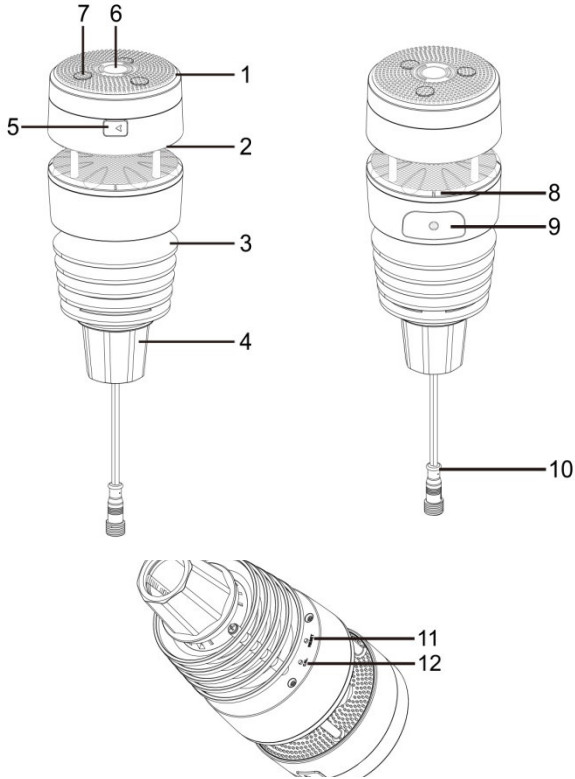

**Figure 1: Wi-Fi Gateway**

Ref.	LED	Description
1	Sensor Link (blue)	<p><b>On:</b> flash when one packet of wireless sensor data was received</p> <p><b>Off:</b> No wireless sensor data is received. Please check whether the wireless sensor is working normally, and make sure that the sensor can connect to the device hotspot "GW2000-WIFIXXX" with a mobile phone/PC, open the browser, and log in to the webpage 192.168. 4.1 (the initial password is empty), enter the Sensors ID interface to re-register the corresponding wireless Sensor .</p>
2	Server (red)	<p><b>On (steady):</b> network communication normal and data uploaded to configured weather service(s) successfully.</p> <p><b>Flash (faster):</b> Wi-Fi configuration mode is active. Use the WS View Plus app to complete the configuration.</p> <p><b>Flash (slow):</b> network communication normal, but upload to one or more configured weather services failed. First confirm Internet access through your router is functioning, and then check whether the upload server account and password are correct (use WS View application).</p> <p><b>Off :</b> Wi-Fi connection failed</p>

**Table 2: LED Indicators**

## 7-in-1 Sensor Array



**Figure 2: Wireless Sensor Array**

1. Solar Panel	7. Haptic Rainfall sensor
2. Ultrasonic wind sensor	8. NORTH alignment indicator
3. Temperature & humidity sensor	9. Battery compartment
4. Fixed Bolt (Mounting on a pole with 1 inch diameter)	10. Heating power cable connector
5. USB port (Factory use only)	11. Reset button
6. Light & UV sensor, LED indicator	12. Calibration button (factory use only)

**Table 3: Sensor assembly detailed items**

# Sensor Array Set up

## 4.1 Install batteries

Insert 2XAA batteries in the battery compartment. The LED indicator(on the top of the sensor) will turn on for 3 seconds and normally flash once every 8.8 seconds (the sensor transmission update period).

**Note:** If no LED light up or is lighted permanently, make sure the battery is inserted the correct way or a proper reset is happened. Do not install the batteries backwards. You can permanently damage the outdoor sensor

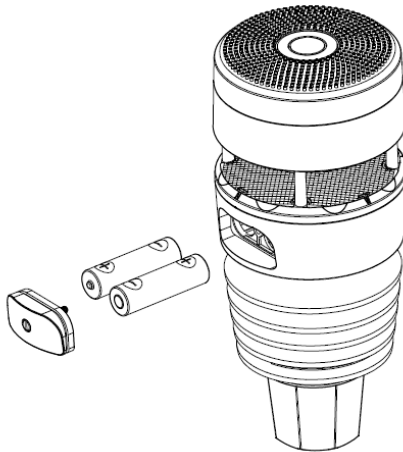

**Figure 3: Battery installation diagram**

**Note:** We recommend lithium batteries for cold weather climates, but alkaline batteries are sufficient for most climates. We do not recommend rechargeable batteries. They have lower voltages, do not operate well at wide temperature ranges, and do not last as long, resulting in poorer reception.

## 4.2. Mounting



## Before you mount

Before installing your outdoor sensor in the permanent location, we recommend operating the device for one week in a temporary location with easy access. This will allow you to check out all of the functions, insure proper operation and familiarize you with the weather station and calibration procedures.

1. Mounting on a pole with 1 inch diameter as Figure 4. Make sure the mounting pole is vertical, or very close to it. Use a level as needed

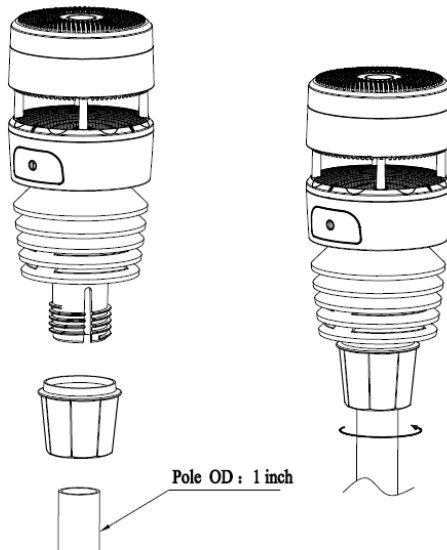

**Figure 4 installation diagram**

Note: Make sure the mounting tube for the sensor package is installed vertically (use a level at 90-degree offsets around the tube). Adjust the mounting pipe as necessary..

2. There is an arrow icon with "N" words (Figure 5) representing the direction of North. The sensor body has to be adjusted so that the "N" indication is facing to real north direction in your location. A compass device is recommended to help adjust direction. Permanent wind direction error will be introduced when the outdoor sensor is not installed in right direction.

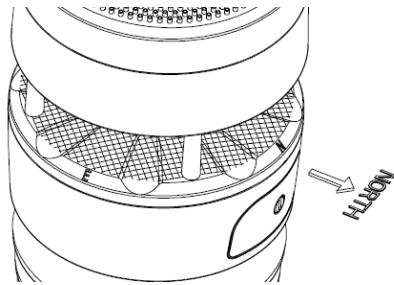

**Figure 5 Facing North diagram**

**Note:** In Southern hemisphere, it is not necessary to change the orientation to SOUTH as its solar panel is a rounded type and it is orientation free for its charging capability.

3. During wintertime, to prevent ice formed on the reflection surface, the optional extension cord be connected to a 12v/1.0A outdoor type power adapter as Figure 6 showed below.

After power by the adaptor, the built-in thermostat heating plate will automatically turns on below 5°C (40°F) and automatically turns off above 10°C (50°F), the heat plate will melts snow and ice and keeps its anemometer working as usual.

**Note:** The outdoor rated adapter and extended power cable can be purchased separately:

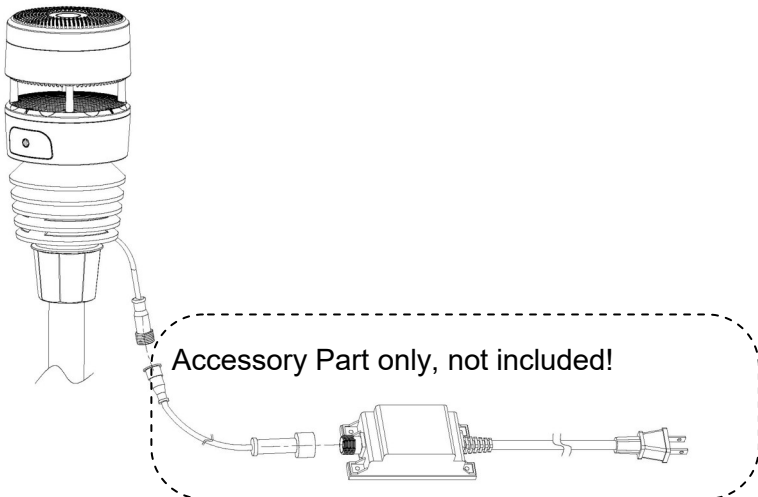

**Figure 6: Sensor package mounting diagram**

### **4.3 Reset Button and Transmitter LED**

In the event the sensor package is not transmitting, reset the sensor.

Press the **RESET** button ,the top LED light will be on for three seconds, then resume as normal, flashing approximately once every 8.8 seconds.

### **4.4. Calibration**

The ultrasonic sensor has been calibration before leaving the factory. We do not recommend that customers do calibration by themselves.

Customers use this feature only when the wind speed does not return to zero when there is no wind

After the product works normally, use a cloth or sponge with good water absorption (prevent the echo of the ultrasonic waves) to completely wrap the air inlet.

Press and hold the CAL button for three seconds, the top LED light will be on. After releasing the CAL button, place the product on the table. After five seconds, the top LED light will flash. At this time it is in the calibration mode. Wait for the LED to flash, the calibration is over, and the product automatically enters the normal working mode.

### **4.5 Site Survey**

Perform a site survey before installing the weather station. Consider the following:

- Ideally mounted at 32.8 feet (10 meters) above ground level.
- Try to make the anemometer the highest object around. 7 feet (2.76 meters) or more above the surrounding obstructions is best.

## Best Practices for Wireless Communication

Wireless (RF) communication is susceptible to interference, distance, walls and metal barriers. We recommend the following best practices for trouble free wireless communication between both outdoor sensors and the gateway:

**Electro-Magnetic Interference (EMI).** Keep the gateway several feet away from computer monitors and TVs.

**Radio Frequency Interference (RFI).** If you have other devices operating on the same frequency band as your indoor and/or outdoor sensors and experience intermittent communication between outdoor sensors and gateway, try turning off these other devices for troubleshooting purposes. You may need to relocate the transmitters or receivers to avoid the interference and establish reliable communication.

**Line of Sight Rating.** This device is rated at 100 meter line of sight (under ideal circumstances; no interference, barriers or walls), but in most real-world scenarios, including a wall or two, you will be able to go about 30 meter

**Metal Barriers.** Radio frequency will not pass through metal barriers such as aluminum siding or metal wall framing. If you have such metal barriers and experience communication problems, you must change the placement of outdoor sensors and gateway.

The following table shows different transmission media and expected signal strength reductions. Each “wall” or obstruction decreases the transmission range by the factor shown below.

Medium	RF Signal Strength Reduction
Glass (untreated)	5-15%
Plastics	10-15%
Wood	10-40%
Brick	10-40%
Concrete	40-80%
Metal	90-100%

**Table 4: RF Signal Strength reduction**

# Wi-Fi Configuration

## 5.1 Before Setup

Connect the Gateway console power jack to AC power with the power adapter (included).

When powered up the Gateway, the Sever LED will flashes quickly. It means that the gateway is in the Wi-Fi configuration mode. If it does not flash quickly, press and hold the top RESET button for 5S to enter the Wi-Fi configuration state

The Gateway console can connect to your network via Wi-Fi or directly connected to your router using the included Ethernet cable.

Place the powered sensors array about 2 to 3 meter from the Gateway console receiver and wait several minutes for the remote sensors to synchronize with the receiver.

## 5.2 Setup Method

### 5.2.1 Method A: Setup via app

Install WS View Plus app. Then follow up the instruction as the App will walk you through the SETUP Process

Remark: We recommend method A to be used in the first place. Please follow the App's instruction to complete account registration and device provision. If method A is not working for you, please follow method B to start

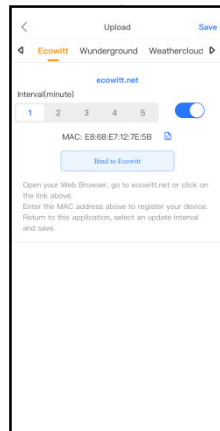
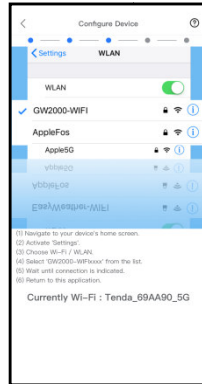

## ECOWITT Dashboard vs WU Dashboard vs Live Data

Here is a short explanation showing data difference:

**Live Data** is obtained by the mobile app by connecting directly to the gateway. This can only happen when your mobile device and gateway are connected to the same Wi-Fi network. It will then show up after you select “Device List” from the main settings menu. If your mobile device is in another network, no device(s) will show up in this list and you will not be able to select a device for displaying the “Live Data” screen.

**ECOWITT Dashboard** shows the data obtained from ECOWITT server. This requires that your mobile device can reach the Internet and therefore this is possible even when you are not on your home Wi-Fi network, such as when using cellular data.

**WU Dashboard** shows the data obtained from WU server. This requires that your mobile device can reach the Internet and therefore this is possible even when you are not on your home Wi-Fi network, such as when using cellular data.

## 5.2.2 Method B: Setup via Embedded Webpage

1. Find the Gateway GW2000X-WIFIXXXX from your device (computer, smart phone, or tablet with a browser) as Figure 7  
Or  
Plug in Ethernet cable to connect this gateway to WiFi router, find its' assigned IP address via DHCP
2. Open a browser, navigate to the following IP address 192.168.4.1 as Figure 8

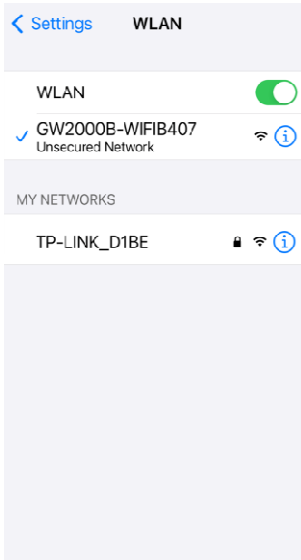

Figure 7

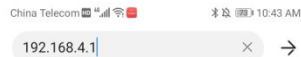
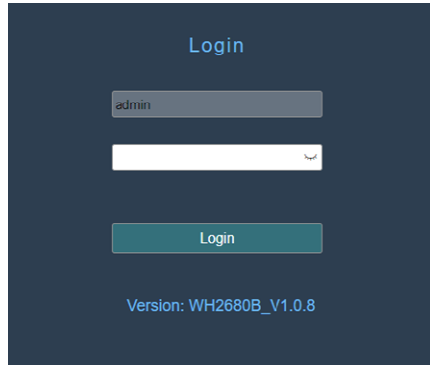

Figure 8

### 3. Enter Login web page as Figure 10.

There is no need to enter the password when you are login for the first time. Press Login button to enter webpage interface.



**Figure 10 Login screen**

### 4. Local Network

Upload data to the weather services, start from here, complete below I to III steps.

I

II

III

After Apply, check whether the IP address is retrieved



## 5. Weather Services

Finished Registration in the weather server you want to upload the data and get the Station ID and Password in the weather Server. Enter it in the below “Weather Server” screen.

The screenshot shows the 'Weather Services' configuration interface. It is divided into several sections: 'Ecowitt.net', 'Wunderground', 'Weathercloud', 'WeatherObservationsWebsite', and 'Customized'. The 'Ecowitt.net' section includes an 'Interval (minutes)' dropdown set to '1' and a 'MAC' field with the value '40:F5:20:0B:7F:72'. The 'Wunderground' section has 'Station ID' and 'Station Key' input fields. The 'Weathercloud' section has 'Weathercloud ID' and 'Weathercloud Key' input fields. The 'WeatherObservationsWebsite' section has 'Station ID' and 'Station Key' input fields. The 'Customized' section has radio buttons for 'Disable' (selected) and 'Enable', and another set for 'Ecowitt' (selected) and 'Wunderground'. Below these are input fields for 'Server IP / Hostname', 'Path' (pre-filled with '/data/report/'), 'Port' (pre-filled with '80'), and 'Upload Interval' (pre-filled with '60' and labeled 'Seconds'). A 'Save' button is at the bottom.

Set the reporting interval time (default: 1 minute).

Mark this MAC, which you will use to add device on the Ecowitt Weather service

**Figure 13 Weather Server screen**

The supported services are shown in the table below:

<b>Hosting Service</b>	<b>Website</b>	<b>Description</b>
Ecowitt Weather	<a href="https://www.ecowitt.net">https://www.ecowitt.net</a>	Ecowitt is a new weather server that can host a bunch of sensors that other services don't support.
Weather Underground	<a href="https://www.wunderground.com">https://www.wunderground.com</a>	Weather Underground is a free weather hosting service that allows you to send and view your weather station data real-time, view graphs and gauges, import text data for more detailed analysis and use iPhone, iPad and Android applications available at Wunderground.com. Weather Underground is a subsidiary of The Weather Channel and IBM.
Weather Cloud	<a href="https://weathercloud.net">https://weathercloud.net</a>	Weathercloud is a real-time weather social network formed by observers from around the world.
Weather Observation Website (WOW)	<a href="http://wow.metoffice.gov.uk/">http://wow.metoffice.gov.uk/</a>	WOW is a UK based weather observation website. WOW allows anyone to submit their own weather data, anywhere in the world.
Customized Website		Supports uploading to your customized website, if the website has the same protocol with Wunderground or Ecowitt

**Table 4: Supported Weather Servers**

## 5.3 Registering Ecowitt Weather Server

It's recommended to use the Ecowitt Weather server to monitor and record your sensors' data.

To register with Ecowitt follow these steps:

- 1) On the Weather Server page, set the reporting interval time (default: 1 minute).
- 2) Visit the website: <https://www.ecowitt.net> on your computer and finish the registration on the page.
  - Press the upper left menu button and select Devices.
  - Press Add Device and input all the information needed (The MAC address can be found on the Weather Server page).
  - Press Save.
  - Press Dashboard on the menu. Your sensor data would be available on the dashboard within several minutes.

The image shows a screenshot of the Ecowitt web interface. On the left is a dark sidebar menu with the 'ecowitt' logo at the top and a close button. The menu items are: Dashboard, Camera, Devices, Alerts, Units, Weather Map, and Languages. The main content area is titled 'Add Device' and contains the following fields: 'Device Name' (text input), 'Device Location' (text input), 'Device Type' (dropdown menu with 'Select' as the current value), 'Timezone' (dropdown menu with 'Asia' selected and 'Shanghai' as a sub-option), and 'MAC' (text input). Below these fields is a 'Public Data' checkbox which is checked. At the bottom of the form are two buttons: 'Cancel' and 'Save'.

Note: When select device address on map, please wait till the map display before select your address.

Note: Please put in the correct time zone to get the correct time. Because the time will be updated to internet time automatically while WIFI connection.

You may add a shortcut to the ecowitt.net website on the home page of your phone so that you can visit it just like opening an app.

### 5.3.1 Viewing data on ecowitt.net

You can observe your sensor’s data by using the ecowitt.net web site. You will use a URL like this one, where your station ID replaces the text “STATIONID”.

<https://www.ecowitt.net/home/index?id=STATIONID>

Note: If you want to share your station data with other users, you’ll need to set your data to be public. Other users need to log in the ecowitt.net first to view your data.

It will show a page such as this, where you can look at today’s data and historical data as well.

### Dashboard



# Graph display

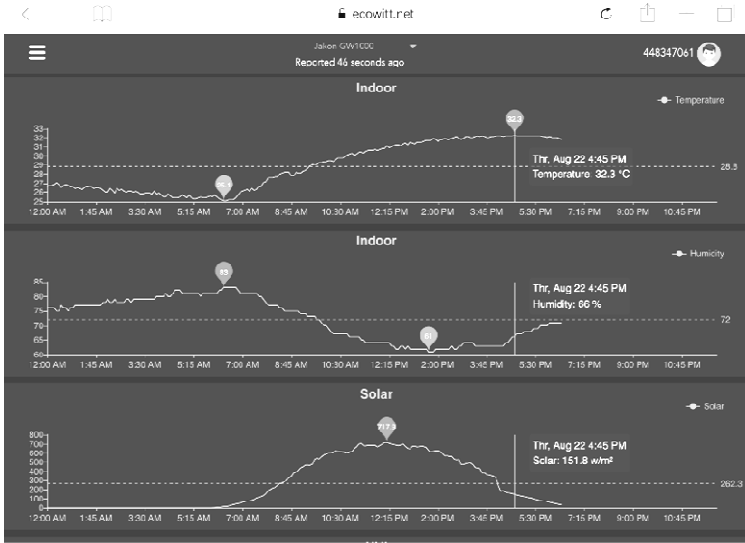

# List display

6:37 PM Thu Aug 22

ecowitt.net

Jakon GW1000  
 Reported 13 seconds ago

448347061

Daily Aug/22/2019

Time	Temperature (°C)	Humidity(%)	Dew Point(°C)	Feels Like(°C)	Temperature (°C)	Humidity(%)	Absolute(hPa)	Relative(hPa)	Wind Speed(m/s)	Wind Gust(m/s)	Wind Dir
2019-08-22 18:30	31.3	77	26.8	40.9	31.8	72	997.8	997.8	1.0	2.0	4
2019-08-22 18:25	31.5	77	26.9	41.3	31.8	71	997.7	997.7	1.1	1.5	2
2019-08-22 18:20	31.5	76	26.8	41.2	31.9	71	997.8	997.8	0.8	1.5	3
2019-08-22 18:15	31.6	76	26.9	41.4	32.0	71	997.7	997.7	0.9	2.0	2
2019-08-22 18:10	31.7	75	26.8	41.5	32.0	71	997.6	997.6	0.7	2.0	3
2019-08-22 18:05	31.8	75	26.8	41.6	32.0	71	997.6	997.6	0.8	2.6	2
2019-08-22 18:00	31.9	74	26.7	41.6	32.1	71	997.5	997.5	1.1	3.1	8
2019-08-22 17:55	31.9	75	26.9	41.9	32.0	70	997.5	997.5	1.1	3.6	7
2019-08-22 17:50	32.1	74	26.9	42.4	32.1	70	997.4	997.4	1.0	2.0	5
2019-08-22 17:45	32.2	74	27.0	42.6	32.1	70	997.4	997.4	1.7	2.6	1
2019-08-22 17:40	32.3	74	27.1	42.9	32.2	70	997.1	997.1	0.6	2.0	2
2019-08-22 17:35	32.5	73	27.0	43.1	32.2	69	997.3	997.3	0.9	2.6	6
2019-08-22 17:30	32.7	72	27.1	43.6	32.2	69	997.4	997.4	0.5	1.5	5

# Weather Map

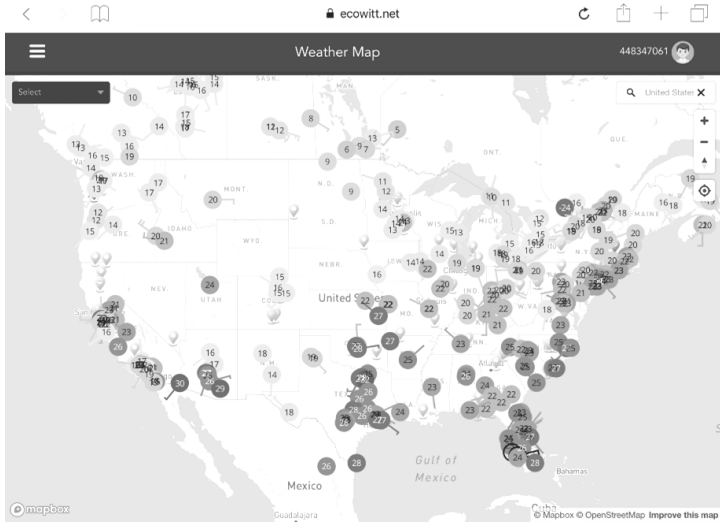

# Email Alerts

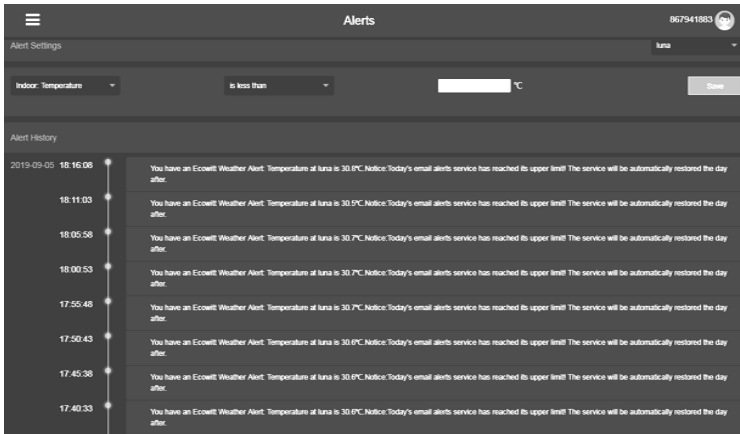

Ecowitt.net is a responsive design and mobile friendly. Simply open your mobile devices web browser, browse to ecowitt.net, and bookmark your dashboard for quick access.

## 5.4 Registering Weather Underground

Perform the following steps to get the Station ID and Password on wunderground.com:

1. Visit Wunderground.com and select the **Join** link at the top of the page and sign up.

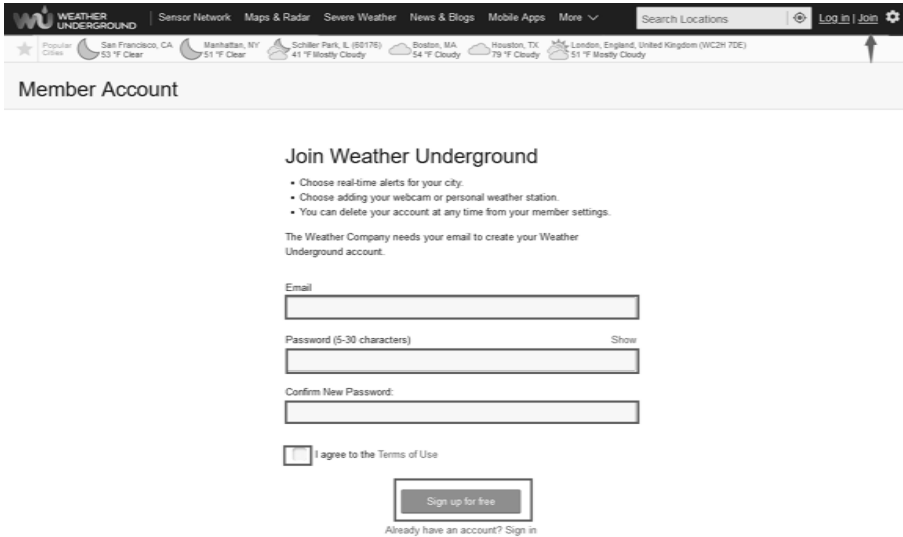

The screenshot shows the Weather Underground website's registration page. At the top, there is a navigation bar with the logo and links for Sensor Network, Maps & Radar, Severe Weather, News & Blogs, Mobile Apps, and More. A search bar and a 'Log in | Join' link are also present. Below the navigation bar, there is a 'Member Account' section. The main heading is 'Join Weather Underground', followed by a list of benefits: 'Choose real-time alerts for your city', 'Choose adding your webcam or personal weather station', and 'You can delete your account at any time from your member settings.' Below this, it states 'The Weather Company needs your email to create your Weather Underground account.' There are three input fields for 'Email', 'Password (5-30 characters)', and 'Confirm New Password:'. A 'Show' link is next to the password field. Below the fields is a checkbox for 'I agree to the Terms of Use'. A 'Sign up for free' button is highlighted with a red box. Below the button, there is a link: 'Already have an account? Sign in'.

2. Click **My Profile** and select **My Devices** to register your station

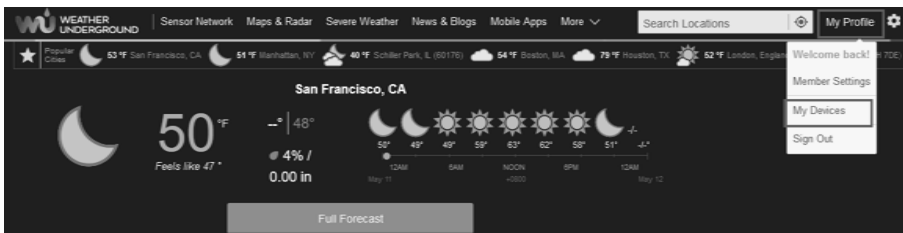

### 3. Select Add New Device.

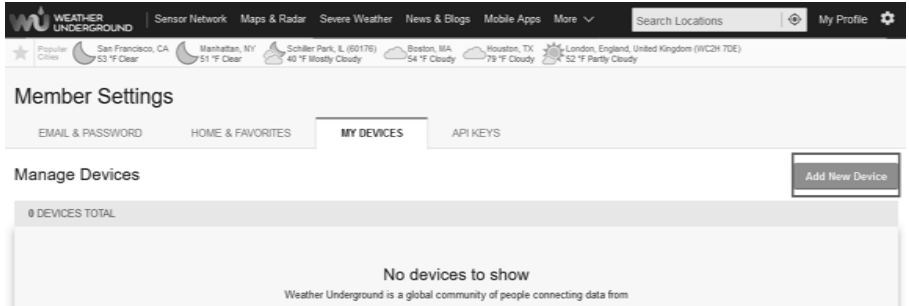

### 4. Find Personal Weather Station. Select 'other' and click 'Next'.

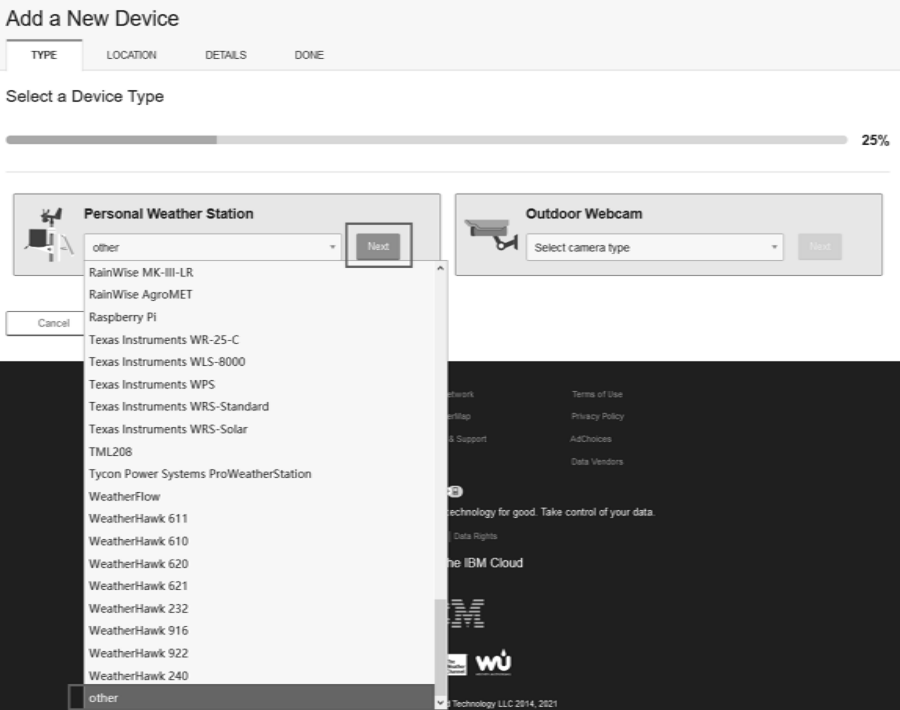



5. Select 'Address' or 'Manual' option, and find your local position. Press 'Next'.

### Add a New PWS

TYPE LOCATION DETAILS DONE

#### Set Device Name & Location

50%

#### Device Location:

Address  Manual

48.101,11.363

Your Location has been verified and added!

Elevation: 1941 ft  
Lat, Lon: 48.101, 11.363  
Neighborhood: Krailling  
Time Zone: Europe/Berlin

Back Next



6. This time you will be asked details about your weather station. Go ahead and fill out the form.

## Add a New PWS

TYPE LOCATION DETAILS DONE

### Tell Us More About Your Device

75%

Name:(Required)

Give Your Device a Name

Surface Type:

Elevation:(Required)

89

Associate Webcam:

Select WebCams

Device Hardware:(Required)

other

Height Above Ground:

Ft. Above Ground

#### You Make Our Forecasts More Accurate, We Respect Your Privacy

Contribute to the Weather Underground community by sharing some information about yourself and your sensor. We use this information to manage your account and to improve the experience from the Weather Underground community. We may also share certain data for commercial purposes, such as your sensor location.

Learn more about how we take your privacy seriously

(Required)

I Accept  I Deny

Email Preferences:

I would like to receive PWS notifications.

Back

Next

- After completing the weather station, you will see station ID and key/password.

## Add a New PWS

TYPE LOCATION DETAILS DONE

### Registration Complete!

100%

Congratulations! Your personal weather station is now registered with Weather Underground.

Enter the information below to your weather station software.

Your PWS  
Station ID: [REDACTED]  
Station Key: [REDACTED]

Copy credentials



- Take note of the station ID and key/password.
- Back to the “Weather Service” screen and input the Station ID and Key.

## 5.4.1 Viewing data on wunderground.com

The most basic way to observe your weather station's data is by using the wunderground.com web site. You will use a URL like this one, where your station ID replaces the text "STATIONID":

<http://www.wunderground.com/personal-weather-station/dashboard?ID=STATIONID>

It will show a page such as this, where you can look at today's data and historical data as well:

**Darwin (+9:30 Zone) Test Station IDARWIN13** About this PWS Report Comments

Forecast for Darwin, AU > -12.460 130.841 > 66 ft

PWS Data PWS Widgets WunderStation My PWS

PWS viewed 3 times since July 1, 2018

Satellite Webcam Icon

Current Conditions Station reported 0 second ago

**78.4 °F**

Feels Like **78.4 °F**

12.1 mph Wind from **ENE**  
Gusts **12.5** mph

Dew Point: **66.2 °F** UV: 0.0  
Humidity: **66%** Solar: 0 w/m<sup>2</sup>  
Precip Rate: **0.00 in/hr** Soil Moisture: --  
Precip Accum: **0.00 in** Soil Temp: --  
Pressure: **29.80 in** Leaf Wetness: --

7:08 AM 6:33 PM  
Waning Gibbous | 50% Illuminated

View WunderMap

Weather History for Darwin, [IDARWIN13]

Previous Daily Mode Jul 6 2018 View Next

Summary July 6, 2018

	High	Low	Average		High	Low	Average
Temperature	82.4 °F	77.4 °F	79.9 °F	Wind Speed	13 mph	--	12 mph
Dew Point	73.8 °F	64.6 °F	70.1 °F	Wind Gust	14 mph	--	--
Humidity	79%	63%	70%	Wind Direction	--	--	West
Precipitation	0 in	--	--	Pressure	29.67 in	29.59 in	--

There are also some very useful mobile apps. The URLs provided here go to the Web version of the application pages. You can also find them directly from the iOS or Google Play stores:

**WunderStation:** iPad application for viewing your station's data and graphs:

<https://itunes.apple.com/us/app/wunderstation-weather-from-your-neighborhood/id906099986>

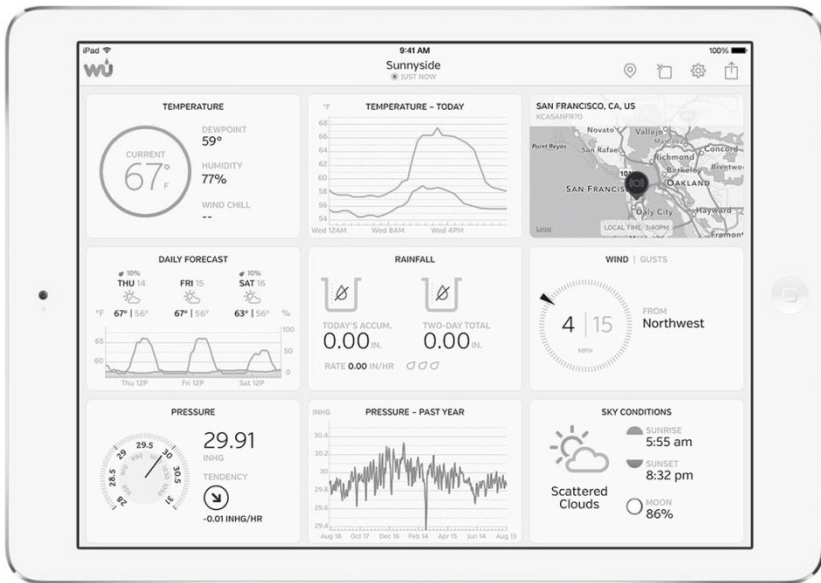

**Weather Underground: Forecast:** iOS and Android application for forecasts

<https://itunes.apple.com/us/app/weather-underground-forecast/id486154808>

<https://play.google.com/store/apps/details?id=com.wunderground.android.weather&hl=en>

### Current conditions at a glance



### Geek out on data

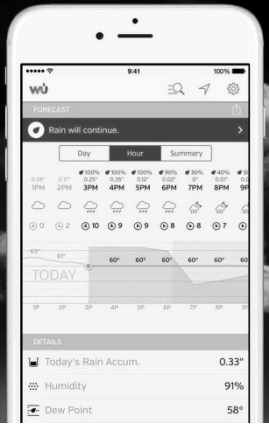

### Interactive radar and satellite



**PWS Weather Station Monitor:** View weather conditions in your neighborhood, or even right in your own backyard. Connects to wunderground.com:

<https://itunes.apple.com/us/app/pws-weather-station-monitor/id713705929>

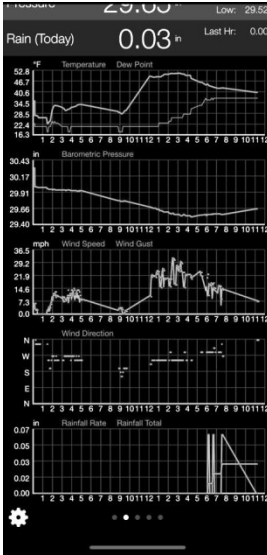

## 5.5 Registering WeatherCloud

To register with Weathercloud follow these steps:

- 1) Visit [weathercloud.net](http://weathercloud.net) and enter a Username, Email and Password to sign up.

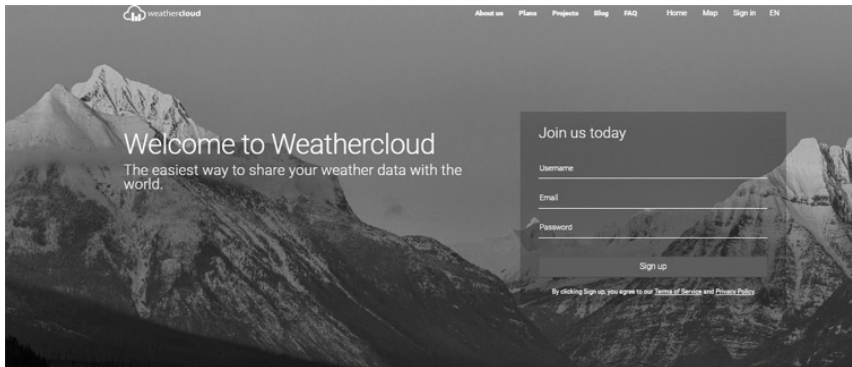

- 2) Respond to the validation email from Weathercloud (it may take a few minutes).
- 3) You will then be prompted to add a device/ Select “Create device” and enter your station’s information:

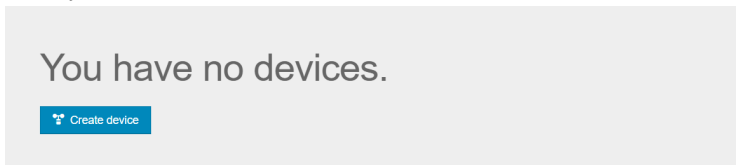

- 4) After registering your station, take note of the “Weathercloud ID” and “Key” presented to you.
- 5) Back to the “Weather Service” screen and input the Station ID and Key.

## 5.6 Weather Observations Website (WOW)

To have your weather station upload data to the Met Office’s WOW site you will need to complete the following steps:

- 1) Sign Up with WOW

Navigate your browser to <http://wow.metoffice.gov.uk>. On the top-right side of the resulting page you will see menu options. Click “Sign Up”

You will be presented with the screen below where you will choose to either create a new account or use an already existing account. Click the desired option.

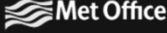

### Register for Weather Observations Website

If you do not already have a Met Office account, please register a new account.

If you already have an account, please add a Weather Observations Website subscription to your existing account.

If you currently access services using <http://services.metoffice.gov.uk> or <http://secure.metoffice.gov.uk>, please register for a new Weather Observations Website account.

If you chose “New Account” you will be presented with a form to fill out:



### Register for Weather Observations Website

<b>First Name</b>	<b>Last Name</b>
<input type="text" value="First Name"/>	<input type="text" value="Last Name"/>
<b>Username</b>	
<input type="text" value="Username"/>	
<b>Password</b>	<b>Confirm Password</b>
<input type="text" value="Password"/>	<input type="text" value="Confirm Password"/>
<b>Email</b>	
<input type="text" value="Email"/>	

The actual form is longer, but all questions should be self-explanatory. Complete and submit the form. You will receive the following notice on completion:



## Registration Successful

You will shortly receive an email with instructions on how to login.

### 2) Confirm your email with WOW

Respond to the validation email from WOW(it may take a few minutes).

### 3) Login to WOW

Follow instructions on the screen and login to the site.

### 4) Create/Set up a new WOW site

Once you are logged in you will need to create a new WOW site. “Sites” are the means by which WOW organizes weather data the you contribute. Basically, WOW builds a personal web site for your weather station. Associated with the web site is two items you will need to allow uploading of data:

**Site ID:** This is an arbitrary number that is used to distinguish your site from another. This number appears (in brackets) next to or underneath the name of your site on the site information page, for example: 6a571450-df53-e611-9401-0003ff5987fd

**Authentication Key:** This is a 6-digit number that is used to ensure data is coming from you and not another user.

Begin setting up a new site by clicking “Enter a Site”:

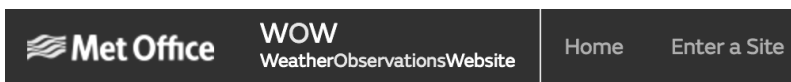

You will be presented with a form where you detail your station’s location and a bunch of other settings related to how you wish the site to operate. After you complete the setup, you should see:

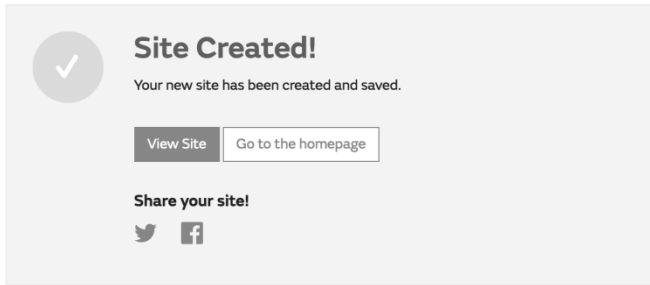

Make sure you are (still) logged in to the WOW site. Login as necessary. Now click on “My Sites” in the navigation bar at the top. If you have only 1 site, you will now be shown its page. If you have multiple, you will have to choose the correct one first. On this page, on the right side you will find the site id just below the map:



You will also need to establish a unique 6 digits PIN code that you should keep secret. It is the “Authentication Key.” Setup this number by clicking on “Edit Site”) and filling out the with a 6-digit number of your choice:

**Authentication Key**

- 5) Back to the “Weather Service” screen and input the Site ID and Authentication Key.

## 5.7 Embedded Webpage other functions

### 1. Device Setting

Set Timezone and Date from here

Live Data

Weather Services

Calibration

Rain Totals

Device Setting

Sensors ID

Local Network

Unit Settings

Version:  
GW1100B\_V2.0.1.1

Device Setting

Sensor Type

If your weather transmitter model is WH24, please turn this option on.

Frequency

RFM915MHz

Auto Timezone

Auto Timezone

Timezone

(UTC)Dublin,Edinburgh,Lisbon,La

Date

2021-06-18 12:33

Upgrade

Automatically upgrade firmware

Save

Login & AP Password

Show password

It can be set to NULL or 8-64 characters, and the device will restart when password is changed.

Apply

Restore default

Reboot

If you select Auto Timezone on Device Setting page, you have to select correct Timezone on Ecowitt.net - Add Device page.



## 2. Live Data

The “Live Data” screen provides a read-out of your sensors and the rename function for the multi-channel sensors.

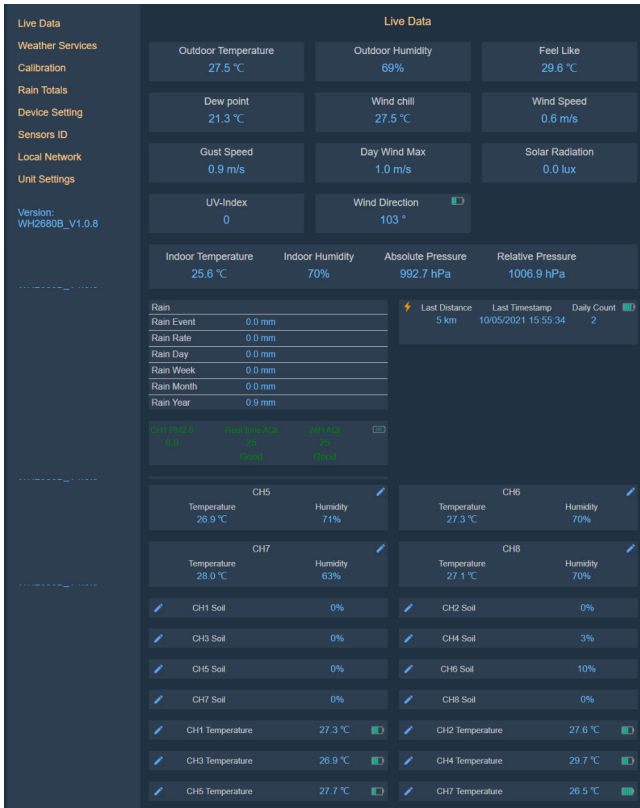



Figure 11 Live Data Screen

Press the pencil icon  and a pop-up window will appear for editing the name of the current channel sensor. For example, rename the received CH1 temperature and humidity to bedroom temperature. After that, this channel will be exposed to bedroom temperature.



**Figure 12 Live Data Screen**

### 3. Calibration

The purpose of calibration is to fine tune or correct for any sensor error associated with the devices margin of error.

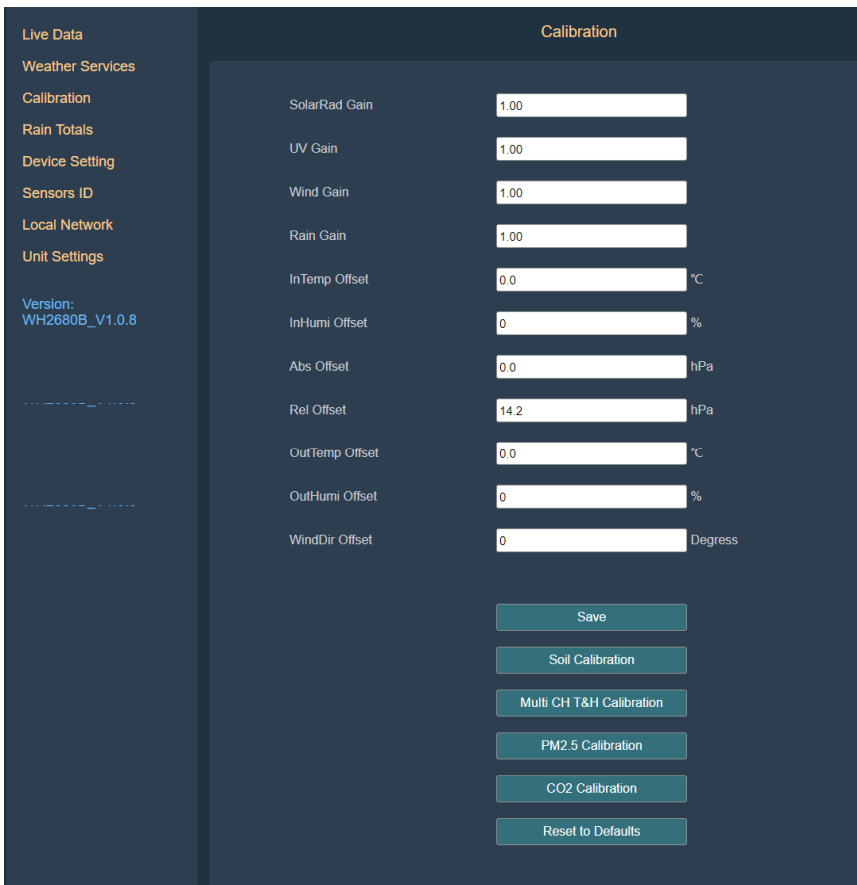

Calibration is only useful if you have a known calibrated source you can compare it against, and is optional. This section discusses practices, procedures and sources for sensor calibration to reduce manufacturing and degradation errors. Do not compare your readings obtained from sources such as the internet, radio, television or newspapers. The purpose of your weather station is to measure conditions of your surroundings, which vary significantly from location to location.

Parameter	Type of Calibration	Default
Solar Radiation	Gain	1.0
UV	Gain	1.0
Wind	Gain	1.0
Rain	Gain	1.0
Temp	Offset	Current Value
Humidity	Offset	Current Value
ABS Barometer	Offset	Current Value
REL Barometer	Offset	Current Value
Wind Direction	Offset	Current Value

**Table 5: Type of Calibration and default value**

The calibration sub-page below is dynamic, and only after receiving the relevant Sensor transmitter, can you go to view, modify and set it.

- Soil Moisture Calibration
- Multi-Channel T&H Calibration
- PM2.5 Calibration
- CO2 Calibration

#### 4. **Rain Totals**

You can edit the rain total for the current day, week, month, or year. This is useful when you start using this system instead of another one that has accumulated data, or simply if you know the values to be incorrect.

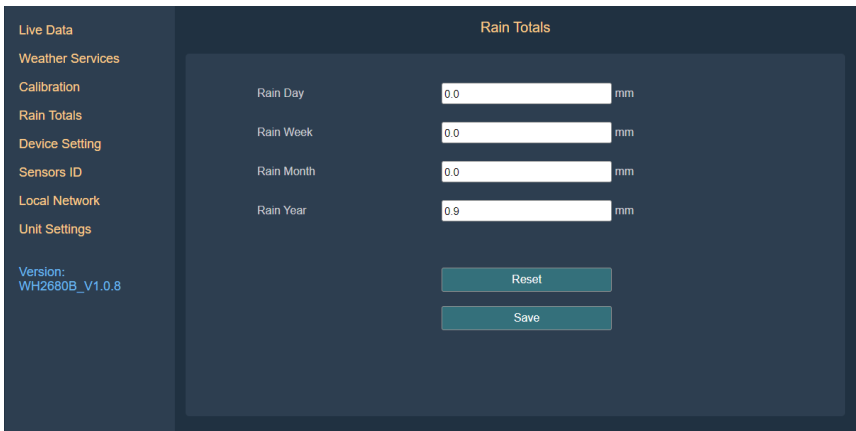

## 5. Sensor ID

On Sensor ID screen to set the following:

View sensor ID, signal strength and battery status

Register the sensor when offline

Enable or disable the sensor

Input the Sensor ID when offline

Live Data

Weather Services

Calibration

Rain Totals

Device Setting

































































Sensors ID

Local Network

Unit Settings

Version:  
WH2690B\_V1.0.8

Sensors ID

Name	ID	Battery	Signal	Re-register	Operating
 Temp & Humidity & Solar & Wind & Rain	0x2	Normal		<a href="#">Re-register</a>	<a href="#">Edit</a>
 Solar & Wind	0xCF			<a href="#">Re-register</a>	<a href="#">Edit</a>
 Rain	0x188E2	Normal		<a href="#">Re-register</a>	<a href="#">Edit</a>
 Temp & Humidity & Pressure	0xB7	Normal		<a href="#">Re-register</a>	<a href="#">Edit</a>
 Temp & Humidity	0x2B	Normal		<a href="#">Re-register</a>	<a href="#">Edit</a>
 Temp & Humidity & Solar & Wind	0x2A			<a href="#">Re-register</a>	<a href="#">Edit</a>
 Lightning	0xC49B			<a href="#">Re-register</a>	<a href="#">Edit</a>
 PM2.5 & PM10 & CO2	0x3572	---		<a href="#">Re-register</a>	<a href="#">Edit</a>
 PM2.5 CH1	0xC4AD			<a href="#">Re-register</a>	<a href="#">Edit</a>
 PM2.5 CH2	Disable	---		<a href="#">Re-register</a>	<a href="#">Edit</a>
 PM2.5 CH3	Disable	---		<a href="#">Re-register</a>	<a href="#">Edit</a>
 PM2.5 CH4	Disable	---		<a href="#">Re-register</a>	<a href="#">Edit</a>
 Leak CH1	Learning	---		<a href="#">Re-register</a>	<a href="#">Edit</a>
 Leak CH2	0x10D4A7			<a href="#">Re-register</a>	<a href="#">Edit</a>
 Leak CH3	Learning	---		<a href="#">Re-register</a>	<a href="#">Edit</a>
 Temp & Humidity CH1	0x8A	Normal		<a href="#">Re-register</a>	<a href="#">Edit</a>
 Temp & Humidity CH2	0x7A	Normal		<a href="#">Re-register</a>	<a href="#">Edit</a>
 Temp & Humidity CH3	0x65			<a href="#">Re-register</a>	<a href="#">Edit</a>
 Temp & Humidity CH4	0xE5	Normal		<a href="#">Re-register</a>	<a href="#">Edit</a>
 Temp & Humidity CH5	0x78	Normal		<a href="#">Re-register</a>	<a href="#">Edit</a>
 Soil moisture CH3	0x80C552	Normal		<a href="#">Re-register</a>	<a href="#">Edit</a>
 Soil moisture CH4	0xC561	Normal		<a href="#">Re-register</a>	<a href="#">Edit</a>
 Soil moisture CH5	0x40C64B	Normal		<a href="#">Re-register</a>	<a href="#">Edit</a>
 Soil moisture CH6	0xC640	Normal		<a href="#">Re-register</a>	<a href="#">Edit</a>
 Soil moisture CH7	0xC690	Normal		<a href="#">Re-register</a>	<a href="#">Edit</a>
 Soil moisture CH8	0x80C516	Normal		<a href="#">Re-register</a>	<a href="#">Edit</a>
 Temp CH1	0x27A2			<a href="#">Re-register</a>	<a href="#">Edit</a>
 Temp CH2	0x78			<a href="#">Re-register</a>	<a href="#">Edit</a>



# Maintenance

## Replacing Batteries Regularly

The Temperature and Humidity Sensor Kit can be replaced whenever required.

1. Use screwdriver to  
uptight the screws of the  
sensor.

2. Unplug the old sensor

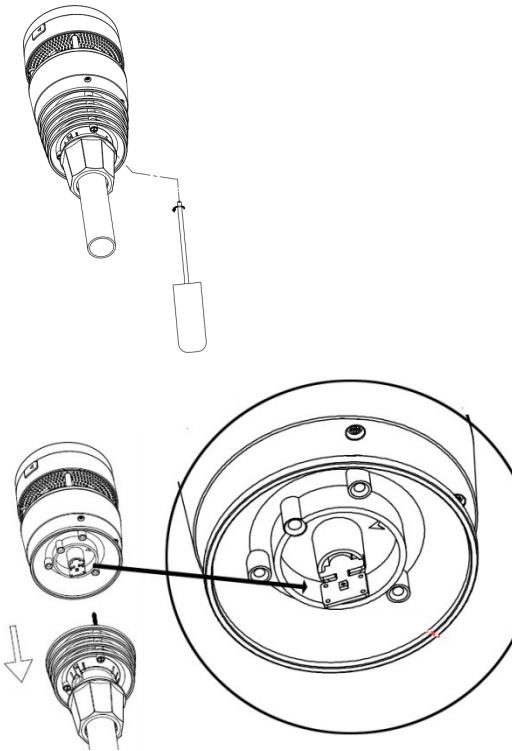

3. Replace the old Temp &  
Humidity sensor with new one

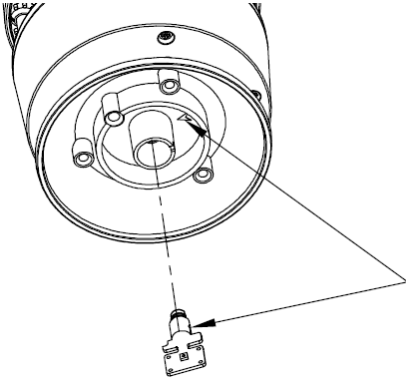

### **Clean Solar Radiation Sensor and Solar Panel**

The solar radiation sensor and solar panel of the outdoor sensor array need to be cleaned with a non-abrasive slightly damp cloth every 3 months.

### **Replacing Batteries Regularly**

Batteries of the outdoor sensor array need to be replaced every 1-2 years for environmental friendly. In serious environments, check the batteries every 3 months and apply a corrosion preventing compound(not included) on the battery terminals for protection.

### **To Prevent Snow build up**

In snowy days, use anti-icing silicon spray on the top of the weather station to prevent snow build up.



# Troubleshooting Guide

Look through the following table and locate an issue or problem you are experiencing in the left column and read possible solutions in the right column.

Problem	Solution
<p>Outdoor sensor not reporting to base unit(gateway)</p> <p>Dashes (--) on the app or website</p>	<p>Check that the outdoor transmission LED is flashing normally. See <b>Sensor reporting interval</b> on Section 8.</p> <p>If the batteries were recently (re)placed, check correct polarity was used and/or reseal the batteries. If the batteries are old, replace them.</p> <p>If the LED is now flashing normally, proceed to the next step. If it is not flashing and you have repeated battery checks and placement, you may have a defective unit.</p> <p>Make sure the gateway is powered and the wifi light(red) lights on steady.</p> <p>Go to the Sensor ID page, find the offline sensor picture and press Re-register to register it.</p>
<p>Indoor and Outdoor Temperature do not agree during indoor testing</p>	<p>During installation testing it is useful to test with both indoor sensor and outdoor unit in the same room. Allow up to one hour for the sensors to stabilize and adjust to room temperature. The indoor and outdoor temperature sensors should agree within 4 °F (the sensor accuracy is <math>\pm 2</math> °F).</p> <p>If these values still disagree, use calibration offsets for one or both sensors (see section 5.5) to adjust to a known good reference temperature.</p>
<p>Indoor and Outdoor Humidity do not agree during indoor testing</p>	<p>The procedure here is that same as for outdoor/indoor temperature. The sensors should agree within 10 % (the sensor accuracy is <math>\pm 5</math> %)</p> <p>If these values still disagree, use calibration offsets for one or both sensors (see section 5.5) to adjust to a known good reference humidity.</p>

Problem	Solution
Relative pressure does not agree with official reporting station	<p>Relative pressure refers to sea-level equivalent temperature and should generally agree closely with the official station. If there is a disagreement, make sure you are not looking at absolute pressure, in particular if your station is not near sea level. Also check at different times due to occasional delays in updates to the official station. Redo the pressure calibration procedure described in section <b>Fehler! Verweisquelle konnte nicht gefunden werden.</b></p> <p>The barometer is only accurate to <math>\pm 0.09</math> inHg (3 hPa) within the following relative pressure range: 20.67 to 32.50 inHg (700 – 1,100 hPa), which corresponds to an altitude of 9,000 ft. (2,750 m) down to 2,500 ft. (750 m) below sea level. At higher altitudes, you should expect a possible lesser accuracy and non-linearity effects in the error (the calibration offset only allows for a partially linear correction).</p>
Time is incorrect	<p>Make sure your time zone and daylight savings time setting is correct (even when connected to the Internet via Wi-Fi this is needed).</p>
Data not reporting to Wunderground.com	<p>Confirm your station ID is correct. The station ID is all caps, and the most common issue is substituting a capital letter O for a 0 (zero) or vice versa. Please note the digit 0 can only occur in the last part of the station ID (which is a station number in a city). Example, KAZPHOEN11, not KAZPH0EN11</p> <p>Confirm that your password (also called: key) is correct. It is the password wunderground.com generated for your station ID. You can also verify it by logging in to wunderground.com and looking it up under “My PWS.”</p> <p>Make sure the date, time and time zone is correct on the WS View app. If it is not incorrect, you may be reporting data for a point in the past or future and you may not see it where you expect it.</p> <p>Check your router firewall settings. The gateway sends data via port 80. If you can access other web sites using “http” (not to be confused with “https”) this setting will be OK.</p>

Problem	Solution
<p>No Wi-Fi connection/Gateway configured failed</p>	<p>Check for Wi-Fi light on the gateway. If wireless connectivity is operational, the Wi-Fi light will be steady.</p> <p>If you have never been able to configure Wi-Fi to a working state, make sure your Wi-Fi supports 2.4 GHz signals (801 type B or G, or N). The gateway does <b>not support</b> Wi-Fi that uses the 5 GHz spectrum.</p> <p>Make sure you configured the correct SSID and password. Repeat the procedure if necessary to verify.</p> <p>The gateway does not support so-called “captive Wi-Fi” networks. These are typically “guest” type networks where users have to agree to terms and conditions before being connected.</p> <p>You can also try the following methods to configure the gateway:</p> <ol style="list-style-type: none"> <li>1. Power off the gateway and wait for several minutes.</li> <li>2. Power on the gateway and hold the Reset button for 5s till the red LED flash fast.</li> <li>3. Open the WIFI network on your phone and connect to the hotspot of GW2000-WIFIXXXX.</li> <li>4. Open the WS View Plus app and click Configure New Device - select GW2000 - click Next</li> <li>5. Follow the instructions on the app.</li> </ol> <p>Method two: Use one phone(A) as a hotspot, find another phone(B) to run WS View app to start the WIFI configuration process(ensure the wifi light is fast flashing) to see whether the configuration can be completed or not.</p> <p>If still failed, please contact our Customer Service Department to solve the issue.</p>

# Specifications

**Note:** Out of range values will be displayed using “---”:

Outdoor sensor	Specification
Transmission distance in open field	150 m (450 ft.)
RF Frequency	868MHz
Temperature range	-40°C – 60°C (-40°F - 140°F)
Temperature accuracy	± 0.3°C, or ± 0.6°F
Temperature resolution	0.1°C, or 0.1°F
Humidity range	1% ~ 99%
Humidity accuracy	±3.5%
Humidity resolution	1%
Rain volume display range	0 – 9999 mm
Rain volume accuracy	± 10%
Rain volume resolution	0.1mm/0.01inch
Wind speed range	0 – 40 m/s (0 ~ 89mph)
Wind speed accuracy	<10m/s, +/-0.5m/s ≥10m/s, +/-5%
Wind direction accuracy	<2m/s, ±10° ≥2m/s, ±7°
UV-Index range	0 - 15
Light range	0 – 200 kLux
Light accuracy	± 15%
Sensor reporting interval	8.8s

**Table: Outdoor sensor specification**

<b>Indoor sensor</b>	<b>Specification</b>
Temperature range	-10°C – 60°C (14°F - 140°F)
Temperature resolution	0.1°C, or 0.1°F
Humidity range	10% ~ 99%
Humidity resolution	1%
Barometric pressure range	300 – 1,100 hPa (8.85 – 32.5 inHg)
Barometric pressure accuracy	± 5 hPa in 700 – 1,100 hPa range
Barometric pressure resolution	0.1 hPa (0.01 inHg)
Sensor reporting interval	60 seconds
Alarm Duration	120 seconds

**Table: Indoor sensor specification**

<b>Power</b>	<b>Specification</b>
Base station/console	5V 1A DC Adapter (a USB to 2.5*0.7mm DC 5V power plug connector cable included)
Outdoor sensor	Solar panel (built-in) 6.5V/4mA
Outdoor sensor (backup)	2 x AA 1.5V battery (not included)

**Table: Power specification**

The primary power source for the outdoor sensor is the solar panel. When available solar power (light over recent period) is insufficient, the batteries will be used. In outdoor climates that frequently have sustained temperatures below 0°C (or 32°F) the use of Lithium batteries is strongly suggested as these are performing better than Alkaline batteries under such circumstances.

### **Transmission between gateway and Wi-Fi router**

Transmission distance in open field: 50 m (165 ft.) depending on router and environment

RF Frequency: 2.4 GHz

WLAN and Ethernet: 802.11 b/g/n (802.11n, Max 150 Mbps)

Updates on the Internet: Customize 1-5 minutes (recommend 1 minute)



## **Caution !**

This booklet may contain errors or misprints. The information is contains is regularly checked and correction are included in subsequence editions. We disclaim any responsibility for any printing error, or their consequences. The specification of this product may change without prior notice.

## **General safety instructions**

### **Danger of asphyxiation:**

Keep all packaging materials (plastic bags, rubber bands, etc.) away from children. There is a danger of suffocation!

### **Danger of burns:**

Caution! Leaking / leaking battery acid can lead to burns! Avoid contact of battery acid with eyes, mucous membranes and skin. In case of contact, rinse the affected areas immediately with clear water and consult a doctor.

### **Risk of electric shock:**

Children must not be unattended with the device, because the device contains electronic parts which are operated by means of a power source. The device may only be used as described in the instructions. If not, there is a risk of electric shock.

### **Danger of fire & explosion:**

Use only recommended batteries. Never short-circuit the unit or batteries. Never throw the device or batteries into a fire! Overheating and improper handling may result in short circuits which can cause fires and explosions.

### **Important:**

If there is a defect, contact your dealer immediately. Never disassemble the device! The dealer will contact the service department. Never expose the device to water! Protect the device from vibrations. Only use recommended batteries. Never mix batteries - Always replace empty batteries with a complete set of full power batteries. If the unit is not powered for a longer period of time or is not in use, remove the batteries from the unit. The manufacturer accepts no liability for incorrectly inserted batteries!



Notes on the return of batteries according to §12 BatterieVO: Batteries do not belong in the household waste. Please dispose of all batteries as required by law, disposal in domestic waste is expressly prohibited. Batteries and rechargeable batteries can be dispensed free of charge at municipal collection points or in the shops on the spot.

This manual may not be reproduced in any form without the written permission of the publisher, even in excerpts.

This manual may contain errors and misprints. However, the information in this manual is regularly reviewed and corrections made in the next issue. We accept no liability for technical errors or printing errors, and their consequences.

All trademarks and copyrights are acknowledged.

[www.froggit.de](http://www.froggit.de)



**HS Group GmbH & Co. KG**

Escherstr.31

50733 Koeln

Germany

Telefon 0221 / 367 48 05

E-Mail [info@hs-group.de](mailto:info@hs-group.de)

Registergericht Amtsgericht Koeln

HRA 26493

Komplementaer: HS Group

Verwaltungsgesellschaft mbH

Sitz Koeln

Registergericht Amtsgericht Koeln

HRB 64734

Geschaeftsfuehrer: Peter Haefele,

Carl Schulte

UStId DE237971721

WEEE Reg. Nr. 66110125

**declaration of conformity**

Hereby we declare, HS-Group GmbH & Co.KG, Escherstr. 31, 50733 D-Cologne, that this product is in compliance with the essential requirements and other relevant provisions of Directive 2014/53/EU.

The declaration of conformity for this product can be found at: [www.froggit.de](http://www.froggit.de) or on request.